

# SIERRA®

SIERRA er et omfattende program af topkvalitets eftermarkeds service- og reservedele til indenbordsmotorer, Z-drev og påhængsmotorer.

Se det komplette katalog på: [www.columbus-marine.dk](http://www.columbus-marine.dk).



## HONDA

### OLIEFILTER



BF8, BF9, BF15, BF20, BF25A,  
BF30A, BF40A, BF45A, BF50A

Varenr.	Pris
18-7913	89,00



BF25, BF30, BF40, BF50

Varenr.	Pris
18-7911-1	128,00



BF75, BF90, BF115, BF130, BF135,  
BF150, BF200, BF225

Varenr.	Pris
18-7909	133,00



### BENZINFILTER



BF90 2007 -,  
BF115 - 1997, 2002 -,  
BF130 2002-04,  
BF135 2004 -, BF150 2004 -,  
BF175 2007 -, BF200 2002 -,  
BF225 2002 -, BF250 - 1997

Varenr.	Pris
18-79908	486,00



Varenr.	Pris
18-7712	159,00



Varenr.	Pris
18-8226	256,00

## VANDUDSKILLER



Varenr.	Beskrivelse	Pris
18-7947	Lille filter	278,00
18-7987	Underskål plast	410,00

Varenr.	Beskrivelse	Pris
18-7948	Stort filter	353,00
18-7922-1	Underskål plast	412,00

## BENZINKOBLING



Varenr.	Slange	Pris
18-80403	8 mm.	154,00

Varenr.	Slange	Pris
18-80407	8 mm.	474,00

Varenr.	Gevind	Pris
18-80400	1/4" NPT	136,00



Varenr.	Slange	Pris
18-80401	10 mm.	267,00

# SIERRA®

## PUMPEBOLD



Pumpebold med dobbelte konventiler med vitonkugler og rustfri stålfejere

EPA/CARB certificeret

Varenr.	Stuts Udv. Ø mm.	Pris
18-8004EP-1	8	354,00
18-8005EP-1	10	368,00

## BENZINSLANGE



Silverado 4000 benzinslange, er den bedste B1 benzinslange på markedet.

Den er modstadsdygtig over for ethanolblandede brændstoffer. Er meget fleksibel, og er vej, og UV resistent CPE.

Varenr.	Indv. Ø mm.	Udv. Ø mm.	Pris pr. mtr.
16-337-0566	8	13	107,00
16-337-0386	10	14	110,00

## TERMOSTAT

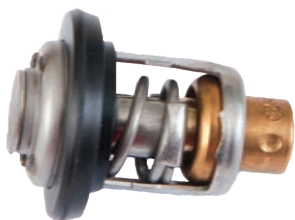

Motor.	Årgang / Kode	Varenr.	Pris
BF5A	1998-06 (6315899)	18-3627	489,00
BF5A	K0,K2,K3 (6315899)	18-3627	489,00
BF8A	1998-00 (6315386)	18-3627	489,00
BF8A	2003-06 (6315386)	18-3627	489,00
BF8A	K0 (6315386)	18-3627	489,00
BF8D	2002-06 (7452345)	18-3628-1	590,00
BF8D	K0,K2,K3 (7452345)	18-3628-1	590,00
BFP8D	2002-06 (7452345)	18-3628-1	590,00
BFP8D	2002-06 (7452352)	18-3628-1	590,00
BFP8D	K0,K2,K3 (7452345)	18-3628-1	590,00
BFP8D	K0,K2,K3 (7452352)	18-3628-1	590,00
BF9,9A	1998-01 (6310494)	18-3627	489,00
BF9,9A	1999-02 (7452360)	18-3627	489,00
BF9,9D	2002-06 (7452345)	18-3628-1	590,00
BF9,9D	K0,K2,K3 (7452345)	18-3628-1	590,00
BFP9,9D	2002-06 (7452345)	18-3628-1	590,00
BFP9,9D	2002-06 (7452352)	18-3628-1	590,00
BFP9,9D	K0,K2,K3 (7452345)	18-3628-1	590,00
BFP9,9D	K0,K2,K3 (7452352)	18-3628-1	590,00
BF15A	1998-01 (6310494)	18-3627	489,00
BF15A	1999-02 (7452360)	18-3627	489,00
BF15D	2003-06 (7452352)	18-3628-1	590,00
BF15D	K0,K2,K3 (7452352)	18-3628-1	590,00
BFP15D	K0,K2,K3 (7452352)	18-3628-1	590,00

Motor.	Årgang / Kode	Varenr.	Pris
BF20D	2003-06 (7452352)	18-3628-1	590,00
BF20D	K0,K2,K3 (7452352)	18-3628-1	590,00
BFP20D	2004-06 (7452352)	18-3628-1	590,00
BFP20D	K0. (7452352)	18-3628-1	590,00
BF25A	2001-03 (7452378)	18-3630	391,00
BF25D	2004-06 (7452378)	18-3628-1	590,00
BF25D	K0,K2,K3 (7452378)	18-3628-1	590,00
BF30A	2001-03 (7452378)	18-3630	391,00
BF30D	2004-06 (7452378)	18-3628-1	590,00
BF30D	K0,K2,K3 (7452378)	18-3628-1	590,00
BF40A	2006-06 (7452386)	18-3630	391,00
BF40D	PRE-1997 (7452386)	18-3628-1	590,00
BF50A	2000-06 (7452386)	18-3628-1	590,00
BF50A	K0. (7452386)	18-3628-1	590,00
BF50D	K2. (7452386)	18-3628-1	590,00
BF50D	PRE-1997 (7452386)	18-3628-1	590,00
BF75A	1997-98 (4921441)	18-3630	391,00
BF75A	1999-02 (6706635)	18-3630	391,00
BF75A	2003-06 (7452394)	18-3630	391,00
BF75D	K0,K2 (7452394)	18-3628-1	590,00
BF90A	1997-98 (4921441)	18-3630	391,00
BF90A	1999-02 (6706634)	18-3630	391,00
BF90A	2003-06 (7452394)	18-3630	391,00
BF90D	K0,K2 (7452394)	18-3628-1	590,00
BF115A	1999-02 (6706634)	18-3630	391,00
BF115A	2003-06 (7452394)	18-3630	391,00
BF115A	K0. (7452394)	18-3630	391,00
BF130A	1999-02 (6706634)	18-3630	391,00
BF130A	2003-04 (7452394)	18-3630	391,00
BF200A	2002-06 (7452402)	18-3628-1	590,00
BF200A	K0,K1,K2 (7452402)	18-3628-1	590,00
BF225A	2002-06 (7452402)	18-3628-1	590,00
BF225A	K0,K1,K2 (7452402)	18-3628-1	590,00

## IMPELLER / REP.SÆT



Motor.	Årgang / Kode	Impeller Varenr.	Pris
BF5A	1998-06 (6315899)	18-3245	256,00
BF5A	K0,K2,K3 (6315899)	18-3245	256,00
BF8A	1998-00 (6315386)	18-3245	256,00
BF8A	2003-06 (6315386)	18-3245	256,00
BF8A	K0 (6315386)	18-3245	256,00
BF8D	2002-06 (7452345)	18-3100	236,00
BF8D	K0,K2,K3 (7452345)	18-3100	236,00
BFP8D	2002-06 (7452345)	18-3100	236,00
BFP8D	2002-06 (7452352)	18-32455	275,00
BFP8D	K0,K2,K3 (7452345)	18-3100	236,00
BFP8D	K0,K2,K3 (7452352)	18-32455	275,00

Rep. sæt uden hus Varenr.	Pris
18-3278	470,00
18-3278	470,00
18-3279	526,00
18-3279	526,00
18-3279	526,00
18-3493	292,00
18-3493	292,00
18-3493	292,00
18-3478	350,00
18-3493	292,00
18-3478	350,00

## IMPELLER / REP.SÆT

Motor.	Årgang / Kode	Impeller Varenr.	Pris	Rep. sæt uden hus Varenr.	Pris
BF9,9A	1998-01 (6310494)	18-3247	265,00	18-4536	275,00
BF9,9A	1999-02 (7452360)	18-3247	265,00	18-3280	294,00
BF9,9D	2002-06 (7452345)	18-3100	236,00	18-3493	292,00
BF9,9D	K0,K2,K3 (7452345)	18-3100	236,00	18-3493	292,00
BFP9,9D	2002-06 (7452345)	18-3100	236,00	18-3493	292,00
BFP9,9D	2002-06 (7452352)	18-32455	275,00	18-3478	350,00
BFP9,9D	K0,K2,K3 (7452345)	18-3100	236,00	18-3493	292,00
BFP9,9D	K0,K2,K3 (7452352)	18-32455	275,00	18-3478	350,00
BF15A	1998-01 (6310494)	18-3247	265,00	18-4536	275,00
BF15A	1999-02 (7452360)	18-3247	265,00	18-3280	294,00
BF15D	2003-06 (7452352)	18-32455	275,00	18-3478	350,00
BF15D	K0,K2,K3 (7452352)	18-32455	275,00	18-3478	350,00
BFP15D	K0,K2,K3 (7452352)	18-32455	275,00	18-3478	350,00
BF20D	2003-06 (7452352)	18-32455	275,00	18-3478	350,00
BF20D	K0,K2,K3 (7452352)	18-32455	275,00	18-3478	350,00
BFP20D	2004-06 (7452352)	18-32455	275,00	18-3478	350,00
BFP20D	K0. (7452352)	18-32455	275,00	18-3478	350,00
BF25A	2001-03 (7452378)	18-3249	367,00	18-3281	365,00
BF25D	2004-06 (7452378)	18-3249	367,00	18-3281	365,00
BF25D	K0,K2,K3 (7452378)	18-3249	367,00	18-3281	365,00
BF30A	2001-03 (7452378)	18-3249	367,00	18-3281	365,00
BF30D	2004-06 (7452378)	18-3249	367,00	18-3281	365,00
BF30D	K0,K2,K3 (7452378)	18-3249	367,00	18-3281	365,00
BF40A	2006-06 (7452386)	18-3248	311,00	18-3282	340,00
BF40D	-1997 (7452386)	18-3248	311,00	18-3282	340,00
BF50A	2000-06 (7452386)	18-3248	311,00	18-3282	340,00
BF50A	K0. (7452386)	18-3248	311,00	18-3282	340,00
BF50D	K2. (7452386)	18-3248	311,00	18-3282	340,00
BF50D	-1997 (7452386)	18-3248	311,00	18-3282	340,00
BF75A	1997-98 (4921441)	18-3056	280,00	18-3214	501,00
BF75A	1999-02 (6706635)	18-3250	504,00	18-3492	398,00
BF75A	2003-06 (7452394)	18-3250	504,00	18-3283	739,00
BF75D	K0,K2 (7452394)	18-3250	504,00	18-3283	739,00
BF90A	1997-98 (4921441)	18-3056	280,00	18-3214	501,00
BF90A	1999-02 (6706634)	18-3250	504,00	18-3492	398,00
BF90A	2003-06 (7452394)	18-3250	504,00	18-3283	739,00
BF90D	K0,K2 (7452394)	18-3250	504,00	18-3283	739,00
BF115A	1999-02 (6706634)	18-3250	504,00	18-3492	398,00
BF115A	2003-06 (7452394)	18-3250	504,00	18-3283	739,00
BF115A	K0. (7452394)	18-3250	504,00	18-3283	739,00
BF115D	K1 (7632797)	18-3250	504,00	18-3284	940,00
BF115D	-1997 (7632797)	18-3250	504,00	18-3284	940,00
BF130A	1999-02 (6706634)	18-3250	504,00	18-3492	398,00
BF130A	2003-04 (7452394)	18-3250	504,00	18-3283	739,00
BF135A	2004-06 (7632797)	18-3250	504,00	18-3284	940,00
BF135A	K0,K2 (7632797)	18-3250	504,00	18-3284	940,00
BF150A	2004-06 (7632297)	18-3250	504,00	18-3284	940,00
BF150A	K0,K2 (7632797)	18-3250	504,00	18-3284	940,00
BF175A	K1. (7452402)	18-3031	569,00	18-3285	852,00
BF175A	K2. (7452402)	18-3031	569,00	18-3285	852,00
BF200A	2002-06 (7452402)	18-3031	569,00	18-3285	852,00
BF200A	K0,K1,K2 (7452402)	18-3031	569,00	18-3285	852,00
BF225A	2002-06 (7452402)	18-3031	569,00	18-3285	852,00
BF225A	K0,K1,K2 (7452402)	18-3031	569,00	18-3285	852,00
BF250A	ALL	18-3031	569,00	18-3489	938,00

## JOHNSON / EVINRUDE

## OLIEFILTER



9.9, 15 2002-07

Varenr.	Pris
18-7903	79,00



25-70 1998-2005

Varenr.	Pris
18-7915-1	139,00



9.9, 15 1995-2001 OMC

Varenr.	Pris
18-7916	145,00



200-225 2004-05

Varenr.	Pris
18-7895	149,00



90-115 EFI 2003-05

Varenr.	Pris
18-7896	151,00



140 EFI 2003-05

Varenr.	Pris
18-7897	160,00

## BENZINFILTER



Johnson 4/5 2003-07,  
6 4-takt 2005-07, 10/15 4-takt 2002-07,  
40/50/60/70 4-takt 2002-06,  
Evinrude 40/50 4-takt 2000-01

Varenr.	Pris
18-7716	102,00



Johnson 25 4-takt 2004-05,  
30 4-takt 2004-07,  
40/60/70 4-takt 2002-06,  
90/115/140 4-takt 2003-04, 2006,  
Evinrude 25/30/40/50/70 4-takt 2000-01

Varenr.	Pris
18-7719	95,00



E-Tec 40, 50, 60, 75, 90, 115, 150,  
175 & 200DPL

Varenr.	Pris
18-7722	114,00



60° V4 + V6

Varenr.	Pris
18-79781	175,00



25 2006-07  
90, 115, 140 4-takt  
2005-06

Varenr.	Pris
18-7953	164,00



Varenr.	Beskrivelse	Pris
18-7828-1	1/4" Lille	80,00
18-7829	1/4" Stor	74,00
18-7830	5/16"	92,00
18-7831	3/8"	88,00

## VANDUDSKILLER



Varenr.	Beskrivelse	Pris
18-7946	Lille filter	145,00

Varenr.	Beskrivelse	Pris
18-7920	Stort filter	390,00
18-7922-1	Underskål plast	412,00

## BENZINKOBLING

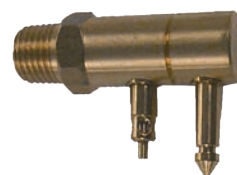
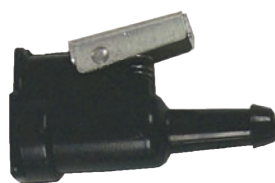

Varenr.	Slange	Pris
18-8056	8 mm.	87,00

Varenr.	Slange	Pris
18-8092	10 mm.	87,00

Varenr.	Gevind	Pris
18-8063	1/4" NPT	124,00

## PUMPEBOLD



Pumpebold med dobbelte kontraventiler med vitonkugler og rustfri stålfljedre

EPA/CARB certificeret

Varenr.	Stuts Udv. Ø mm.	Pris
18-8004EP-1	8	354,00
18-8005EP-1	10	368,00

## BENZINSLANGE



Silverado 4000 benzinslange, er den bedste B1 benzinslange på markedet.

Den er modstadsdygtig over for ethanolblandede brændstoffer. Er meget fleksibel, og er vej, og UV resistent CPE.

Varenr.	Indv. Ø mm.	Udv. Ø mm.	Pris pr. mtr.
16-337-0566	8	13	107,00
16-337-0386	10	14	110,00

Sierra Sonar er et on-line program hvor du nemt og hurtigt finder den korrekte Sierra reservedel. Der kan søges på originalnumre, Sierra numre og motormodel.

<https://catalog.seastarsolutions.com>



## TERMOSTAT

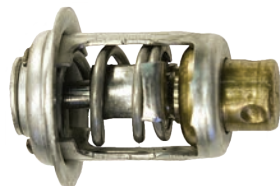

# SIERRA®



Motor.	Årgang	Termostat Varenr.	Pris
6HK 4T.	1998-	18-3561	195,00
8HK.	1980-05	18-3543	273,00
9,9/15 4T.	1995-	18-3543	273,00
15HK.	2011-	18-3543	273,00
20HK.	1985-	18-3543	273,00
25HK.	2011-	18-3543	273,00
30HK.	2011-	18-3543	273,00
35HK.	1996-01	18-3561	195,00
40HK.	1999-	18-3561	195,00
50HK.	1989-98	18-3643	273,00
60HK.	1995-	18-3561	195,00
65HK.	1995-	18-3561	195,00
70HK.	1995-	18-3561	195,00
90HK.	2013-	18-3543	273,00
90HK. SL.DI	1995-	18-3543	273,00
115HK.	2013-	18-3543	273,00
115HK.SL.DI	1995-	18-3543	273,00
125 ESX 25"	1994-95	18-3561	195,00
130HK	2013-	18-3543	273,00
135HK. 25"	2001.	18-3561	195,00
150HK.	2000-	18-3544	313,00
175HK.	2000-	18-3543	273,00
200HK.	2009-	18-3543	273,00
225HK.	2009-	18-3543	273,00
250HK.	2009-	18-3543	273,00
300HK.	2009-	18-3543	273,00

Termostat Pakning Varenr.	Pris
18-0182	17,00
18-0182	17,00
18-0182	17,00
18-0182	17,00
18-0182	17,00
18-0182	17,00
18-0182	17,00
18-0182	17,00
18-0182	17,00
18-0182	17,00
18-0182	17,00
18-0182	17,00
18-0182	17,00
18-0182	17,00
18-0182	17,00

## IMPELLER / REP.SÆT



# SIERRA®

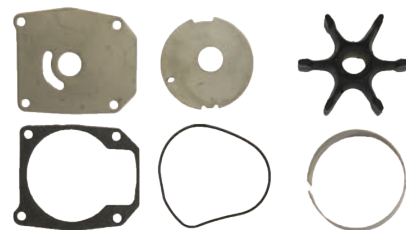

Motor.	Årgang	Impeller Varenr.	Pris
2,5HK	1997-06	18-3015	214,00
3,5HK	1987-06	18-3015	214,00
4HK.	1986-92	18-3091	225,00
4HK Ultra Excel	1980-06	18-3015	214,00
5HK.	1980-01	18-3091	225,00
5HK 4T.	1998-	18-3091	225,00
6HK	1994-05	18-3091	225,00
6HK 4T.	1998-	18-3091	225,00
8HK.	1980-05	18-3091	225,00

Rep. sæt uden hus Varenr.	Pris
18-4529	452,00
18-4529	452,00
18-4529	452,00
18-4529	452,00

## IMPELLER / REP.SÆT

Motor.	Årgang	Impeller Varenr.	Pris
9,9/15 4T.	1995-	18-3050	180,00
15HK.	2011-	18-4539	211,00
20HK.	1985-	18-3051	233,00
25HK.	2011-	18-4539	211,00
30HK.	2011-	18-4539	211,00
35HK.	1996-01	18-3051	238,00
40HK.	1999-	18-3053-1	338,00
50HK.	1989-98	18-3104-1	439,00
60HK.	1995-	18-3053-1	338,00
65HK. Comm.	1995-	18-3053-1	338,00
70HK.	1995-	18-3053-1	338,00
90HK.	2013-	18-3059	315,00
90HK. SL.DI	1995-	18-3059	315,00
115HK.	2013-	18-3059	315,00
115HK.SL.DI	1995-	18-3059	315,00
125 ESX 25"	1994-95	18-3059	315,00
130HK	2013-	18-3059	315,00
135HK. 25"	2001.	18-3059	315,00
140HK. 25"	1994-2000	18-3059	315,00
150HK.	2000-	18-3059	315,00
175HK.	2000-	18-3059	315,00
200HK.	2009-	18-3059	315,00
225HK.	2009-	18-3059	315,00
250HK.	2009-	18-3059	315,00
275HK.	2009-	18-3059	315,00
300HK.	2009-	18-3059	315,00

Rep. sæt uden hus Varenr.	Pris
18-3400	618,00
18-4537	913,00
18-3381	660,00
18-4537	913,00
18-4537	913,00
18-3491	1.028,00
18-3394	1.058,00
18-3394	1.058,00
18-3387	810,00
18-3387	810,00
18-3387	810,00
18-3476	951,00
18-3390	698,00
18-3476	951,00
18-3390	698,00
18-3390	698,00
18-3476	951,00
18-3390	698,00
18-3390	698,00
18-3390	698,00
18-3472	1.087,00
18-3472	1.087,00
18-3472	1.087,00
18-3472	1.087,00
18-3472	1.087,00
18-3472	1.087,00

## MERCURY / MARINER

### OLIEFILTER



9.9 S/N OH000058-OH017099  
1995-98

Varenr.	Pris
18-7901	219,00



8 2001-2004  
9.9 1999-2004  
15 1998 -  
20 2008 -  
30 2006 -

Varenr.	Pris
18-7913	89,00



25 1998-2005  
30 1999-2005  
40, 50, 60 1995 -  
75, 90 karburator 2000-2005  
115 EFI op til S/N 1B366822

Varenr.	Pris
18-7914	93,00



75/90 115  
Fra S/N 1B366823 - 2B094995  
150 4-takt fra S/N 7B905505 -

Varenr.	Pris
18-7758	105,00



225 Ikke Verado

Varenr.	Pris
18-7906-1	118,00



Verado 135-200, Inline 4 cylinder

Varenr.	Pris
18-7921	103,00



Se komplet katalog på columbus-marine.dk



Verado 200-350, Inline 6 cylinder

Varenr.	Pris
18-7918	108,00

## BENZINFILTER



6 - 25 2-takt

Varenr.	Pris
18-7802	92,00



4/5 2 cyl 1999 -,  
4/5/6 4-takt 1999 -,  
8/9.9 4-takt 2005 -

Varenr.	Pris
18-7712	159,00



9.9 4-takt 1995-98,  
15 4-takt 1998 -

Varenr.	Pris
18-7713	178,00



25 4-takt 1998 -, 30 4-takt 1999-01,  
30 3 cyl 4-takt 1999-01,  
40 4-takt 1998-01,  
40 4-takt 4 cyl 2001-02,  
40 Carb 3-cyl 4-takt 2002 -,  
50 4-takt 4 cyl 2001-02,  
60 4-takt 4 cyl 2001-02,  
75 4-takt 2000 -,  
90 4-takt 2000 -

Varenr.	Pris
18-7714	180,00



135/150/175 4-takt Verado S/N 1B227000 -,  
200/225 4-takt Verado S/N OT980000 -,  
250/275 4-takt Verado S/N OT801000 -

Varenr.	Pris
18-7718	107,00



115 EFI 4-takt,  
75 4-takt,  
90 4-takt

Varenr.	Pris
18-7979	224,00



Verado,  
90 DFI 3 cyl, 115 DFI 3 cyl  
200 DFI / 225 DFI

Varenr.	Pris
18-7981	409,00



225 EFI 4-takt 2003 - 2006

Varenr.	Pris
18-7936	311,00



Varenr.	Beskrivelse	Pris
18-7828-1	1/4" Lille	80,00
18-7829	1/4" Stor	74,00
18-7830	5/16"	92,00
18-7831	3/8"	88,00

## VANDUDSKILLER



Varenr.	Beskrivelse	Pris
18-7944	Kort filter	118,00

Varenr.	Beskrivelse	Pris
18-7945	Langt filter	101,00

## BENZINKOBLING



Varenr.	Slange	Pris
18-8076	10 mm.	85,00



Varenr.	Slange	Pris
18-80410-1	10 mm.	115,00

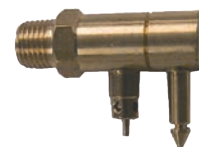

Varenr.	Gevind	Pris
18-8077-1	1/4" NPT	181,00



Varenr.	Slange	Pris
18-80412	8 mm.	216,00



Varenr.	Slange	Pris
18-8091	10 mm.	172,00



Varenr.	Gevind	Pris
18-80402	1/4" NPT	231,00



Varenr.	Slange	Pris
18-8069	8 mm.	176,00



Varenr.	Slange	Pris
18-8070	8 mm.	155,00

# SIERRA®

## Pumpebold



Pumpebold med dobbelte kontraventiler med vitonkugler og rustfri stålfjedre

EPA/CARB certificeret

Varenr.	Stuts Ud. Ø mm.	Pris
18-8004EP-1	8	354,00
18-8005EP-1	10	368,00

## Benzinslange



Silverado 4000 benzinslange, er den bedste B1 benzinslange på markedet.

Den er modstadsdygtig over for ethanolblandede brændstoffer. Er meget fleksibel, og er vej, og UV resistent CPE.

Varenr.	Indv. Ø mm.	Udv. Ø mm.	Pris pr. mtr.
16-337-0566	8	13	107,00
16-337-0386	10	14	110,00





## IMPELLER / REP.SÆT

Motor.	Serienummer	Impeller Varenr.	Pris	Rep. sæt uden hus Varenr.	Pris
8HK	A197112 -	18-3062	221,00		
8HK. 4T.Bodensee	G760300 -	18-3062	221,00		
9,8HK	5206550 -	18-3039	184,00	18-3239	241,00
9,9HK	A197112 -	18-3062	225,00		
9,9HK.4T.Std.Case	G760300 - T979999	18-3062	225,00		
XR10 SeaPro	D03800 -	18-3062	225,00		
10HK	500022 - 1057993	18-3008	352,00		
15HK	B292417 -	18-3062	225,00		
15HK SeaPro	G044365 -	18-3062	225,00		
18HK	5837437 -	18-3057	237,00		
20HK	860970 - 1292909	18-3008	352,00		
20HK	2827677 - 6443972	18-3052	258,00	18-3252	439,00
20HK	6443973 -T800749	18-3057	237,00	18-3215	419,00
22HK	1158546 -1238089	18-3008	352,00		
25,25XD,SEAPRO	5705532 -	18-3057	237,00	18-3215	419,00
25HK.(3 CYL)	E268781 -	18-3057	237,00	18-3515	419,00
30HK	950250 - 1260724	18-3008	352,0		
30HK	1271884 - 148139	18-3007	208,00	18-3207	376,00
30 JET	C159200 - G589999	18-3007	208,00	18-3207	376,00
30 JET	G590000 -	18-3057	237,00		
30HK.(2 CYL)	G053314 -T598999	18-3057	237,00		
35HK	1217222 - 1448139	18-3007	208,00		
35HK	1571114 -1960826	18-3007	208,00	18-3207	376,00
35HK	1960827 - 2453068	18-3007	208,00	18-3207	376,00
35HK	6445653 -	18-3007	208,00	18-3207	376,00
40HK	941751 -1224480	18-3008	352,00		
40HK	1224481 - 1476509	18-3007	208,00		
40HK	2874704 - 4362214	18-3007	208,00	18-3207	376,00
40HK.(2CYL)-1983	4860103 -	18-3057	237,00		
40HK.(3 CYL)	G531301 -	18-3057	237,00		
40HK.(4 CYL)	C159200 -	18-3007	208,00	18-3207	376,00
40HK.4T.2:1 RATIO	G760300 - T408999	18-3057	237,00		
40 EFI 4T. 1,83:1 RATIO	T409000 -	18-8900	423,00		
40 EFI 4T. 2,31:1 RATIO	T409000 - B344398	18-3056	280,00	18-3214	501,00
40(4 CYL) 4T.2,31:1 RATIO	T228405 - T598999	18-3056	280,00	18-3214	501,00
40HK. 4T.STD.	G231123 - T178499	18-3057	237,00		
40. 4T.CARB.BIG FOOT	C033811 -	18-3056	280,00		
40HK.	1279685 - 1476509	18-3007	208,00		
45HK.	5531630 -	18-3007	208,00	18-3207	376,00
45 JET (3 CYL )	D000750 -	18-8900	423,00		
45. 4T.STD.BODENSEE	G231123 -	18-3057	237,00		
45.4T.BIGFOOT.BODENSE	G231123 -	18-3056	280,00	18-3214	501,00
50HK.	1421113 - 1460498	18-3007	208,00		
50HK.	1477910 - 1521913	18-3007	208,00		
50HK.	1521914 - 2305100	18-3007	208,00	18-3207	376,00
50HK. (4 CYL)	4357640 - 5531629	18-3007	208,00	18-3207	376,00
50HK. (4 CYL)	5531630 -	18-3007	208,00		
50HK. (4 CYL)	4962056 -	18-3007	208,00	18-3207	376,00
50HK. (3 CYL)	6428681 - D000749	18-3007	208,00	18-3207	376,00
50HK. (3 CYL)	D000750 - G589999	18-8900	423,00		
50HK. (3 CYL)	G590000 -	18-3057	237,00		
50HK. 4T. STD.	G231123 - T178499	18-3057	237,00		
50HK.4T.(4 CYL) STD.	T178500 - T598999	18-8900	423,00		
50.4T.(4 CYL)BIG FOOT	T178500 -	18-3056	280,00	18-3214	501,00
50.EFI. 4T. STD.	T409000 - B344398	18-8900	423,00		

## IMPELLER / REP.SÆT

Motor.	Serienummer	Impeller Varenr.	Pris	Rep. sæt uden hus Varenr.	Pris
50.EFI. 4T. BIG FOOT	T409000 - B344398	18-3056	280,00	18-3214	501,00
55HK. (3 CYL)	D000750 -	18-8900	423,00		
60HK.	6428681 - D000749	18-3007	208,00	18-3207	376,00
60HK. (3 CYL ) Std.	D000750 -	18-3056	280,00	18-3214	501,00
60HK. Marathon	D000750 -	18-3056	280,00	18-3214	501,00
60HK. Big Foot	D000750 -	18-3056	280,00	18-3214	501,00
60HK. (3 CYL )	D000750 -	18-8900	423,00		
60HK. 4T. Std.	OT178500 - T598999	18-8900	423,00		
60HK. 4T.Big Foot	OT178500 - T598999	18-8900	423,00		
60HK.4T.Efi.Big Foot	T409000 - B344398	18-3056	280,00		
65HK. (3 CYL)	3293184 - 4382056	18-3007	208,00	18-3207	376,00
65HK. (3 CYL)	4382057 - 4571651	18-3007	208,00	18-3207	376,00
65 JET	OD293222 -	18-3056	280,00	18-3214	501,00
70HK.	143611 -1436114	18-3017	259,00	18-3217	371,00
70HK (3CYL)	4571652 -4977156	18-3007	208,00	18-3207	376,00
70HK.	4977157 -6428680	18-3007	208,00	18-3207	376,00
70HK.	B110054 -	18-3056	280,00	18-3214	501,00
70HK. (3 CYL)	A996142 - C221999	18-3056	280,00		
75HK. (4 CYL)	6432901 -	18-3017	259,00	18-3217	371,00
75HK. (3 CYL)	A996142 - C221999	18-3056	280,00	18-3214	501,00
75HK. (3 CYL)	C222000 -	18-3056	280,00	18-3214	501,00
75HK. (3 CYL)OPTIMAX	T980000 -	18-3056	280,00		
75HK. 4T.	G980500 - B366822	18-3056	280,00	18-3214	501,00
75HK. 4T.	B366823 -	18-3056	280,00		
80HK.	1355468 -3493912	18-3017	259,00	18-3217	371,00
80HK (6 CYL)	1335465 - 1398629	18-3017	259,00		
80HK (4 CYL)	4831999 - 6432900	18-3017	259,00	18-3217	371,00
80HK (3 CYL)	A996142 - C221999	18-3056	280,00	18-3214	501,00
80 JET	D283222 -	18-3056	280,00	18-3214	501,00
90HK (6 CYL )	4845301 -	18-3017	259,00	18-3217	371,00
90HK (3 CYL )	B110054 - C221999	18-3056	280,00	18-3214	501,00
90HK (3 CYL )	A996142 -	18-3056	280,00	18-3214	501,00
90HK 4T.	G960500 - B366822	18-3056	280,00	18-3214	501,00
90HK 4T.	B366823 -	18-3056	280,00	18-3214	501,00
100HK (4 CYL)	0A722297 - 0D283221	18-3056	280,00		
105 JET	OD182000 -	18-3017	259,00	18-3217	371,00
115HK ( 6 CYL)	2836019 -4112634	18-3017	259,00	18-3217	371,00
115HK ( 6 CYL)	4112635 - 4394236	18-3017	259,00		
115HK ( 6 CYL)	4394237 -	18-3017	259,00	18-3217	371,00
115HK( 4 CYL)	C100000 -	18-3056	280,00	18-3214	501,00
115HK( 4 CYL)	B2094668 -	18-3056	280,00	18-3214	501,00
115HK. 4 T.	T178500 - B366822	18-3056	280,00	18-3214	501,00
115HK. 4 T.	B366823 -	18-3056	280,00		
115HK.(3 CYL)OPTIMAX	T801000 -	18-3056	280,00		
115HK. PRO XS	1B751825 -	18-3056	280,00		
125HK. ( 6 CYL )	2314956 - 2839368	18-3017	259,00	18-3217	371,00
125HK. ( 4 CYL )	D283222 -	18-3056	280,00		
125HK.(3CYL)OPTIMAX	B7336885 -	18-3056	280,00		
135HK.	2839369 - 3293233	18-3017	259,00	18-3217	371,00
135HK. V.	904646 -	18-3017	259,00	18-3217	371,00
135HK.V. DFI	G590000 -	18-3017	259,00		
135HK.4T.VERADO	B227000 -	18-3056	280,00		
140HK.	3293234 -3502805	18-3017	259,00	18-3217	371,00
140HK.	4865678 -	18-3017	259,00	18-3217	371,00
140 JET.	D082000 -	18-3017	259,00	18-3214	501,00



## SUZUKI

## OLIEFILTER



DF9.9, DF15 1996-2006

Varenr.	Pris
18-7903	79,00



DF9.9, DF15 2006 -

Varenr.	Pris
18-8870	100,00



DF25-DF70

Varenr.	Pris
18-7915-1	139,00



DF70A, DF80A, DF90A, DF90-DF115

Varenr.	Pris
18-7896	151,00



DF140

Varenr.	Pris
18-7897	160,00



DF150-DF300

Varenr.	Pris
18-7905-1	253,00

## BENZINFILTER



Varenr.	Pris
18-7719	95,00



DF25-DF140 - 2006

Varenr.	Pris
18-7716	102,00



DF25-DF140 2006 -

Varenr.	Pris
18-7953	164,00



DF150-DF175

Varenr.	Pris
18-7711	133,00

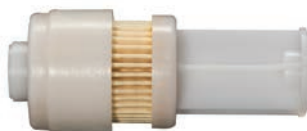

DF200-DF300

Varenr.	Pris
18-7936	280,00



Varenr.	Beskrivelse	Pris
18-7828-1	1/4" Lille	80,00
18-7829	1/4" Stor	74,00
18-7830	5/16"	92,00
18-7831	3/8"	88,00

## VANDUDSKILLER



Varenr.	Beskrivelse	Pris
18-7947	Lille filter	278,00
18-7987	Underskål plast	410,00

Varenr.	Beskrivelse	Pris
18-7948	Stort filter	353,00
18-7922-1	Underskål plast	412,00

## BENZINKOBLING



Varenr.	Slange	Pris
18-80404	10 mm.	260,00



Varenr.	Slange	Pris
18-80419	8 mm.	229,00



Varenr.	Slange	Pris
18-80425	8 mm.	189,00



11 mm.

Varenr.	Slange	Pris
18-8062	10 mm.	185,00



11 mm.

Varenr.	Gevind	Pris
18-8071	1/4" NPT	100,00

Se komplet katalog på columbus-marine.dk



13 mm.

Varenr.	Slange	Pris
18-8079	10 mm.	195,00



13 mm.

Varenr.	Gevind	Pris
18-8078	1/4" NPT	175,00



## Pumpebold



Pumpebold med dobbelte kontraventiler med vitonkugler og rustfri stålfjedre

EPA/CARB certificeret

Varenr.	Stuts Ud. Ø mm.	Pris
18-8004EP-1	8	354,00
18-8005EP-1	10	368,00

## Benzinslange



Silverado 4000 benzinslange, er den bedste B1 benzinslange på markedet.

Den er modstadsdygtig over for ethanolblandede brændstoffer. Er meget fleksibel, og er vej, og UV resistent CPE.

Varenr.	Indv. Ø mm.	Udv. Ø mm.	Pris pr. mtr.
16-337-0566	8	13	107,00
16-337-0386	10	14	110,00

## IMPELLER / REP.SÆT



# SIERRA®

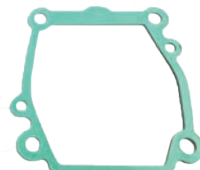

Motor.	Årgang	Impeller Varenr.	Pris
DT2/2,2	1983-97	18-3097	213,00
DT3,5	1983-84	18-3097	213,00
DT4	19984-98	18-3097	213,00
DF4	2003-10	18-3097	213,00
DT5	1999-02	18-3097	213,00
DT6	1984-02	18-3097	213,00
DF6	2003-10	18-3097	213,00
DT8	1990-87	18-3097	213,00
DT8	1988-97	18-3000	204,00
DF8	2010.	18-3099	180,00
DT9,9	1983-87	18-3099	180,00
DT9,9	1988-97	18-3000	204,00
DF9,9	1997-10	18-3099	180,00
DT15	1983-97	18-3099	180,00
DT15C	1989-97	18-3099	180,00
DF15	1997-10	18-3099	180,00
DT20	1986-88	18-3096	294,00
DT25	1983-88	18-3096	294,00
DF25	2000-06	18-3096	294,00
DF25 V-TWIN	2006-10	18-3096	294,00
DT30	1983-87	18-3096	294,00
DF30	2000-07	18-3096	294,00
DT35	1987-89	18-3096	294,00
DT40/DT4040C	1984-98	18-3096	294,00
DF40	1999-09	18-3096	294,00
DF40	2010.	18-3096	294,00
DT50	1983-84	18-3094	347,00
DF50	1999-09	18-3096	294,00
DF50	2010.	18-3096	294,00
DT55	1985-97	18-3094	347,00
DF60	1998-09	18-3049	511,00
DF60	2010.	18-3096	294,00
DT65	1985-97	18-3094	347,00
DF70	1998-09	18-3049	511,00
DF70	2010.	18-3096	294,00
DT75	1983-97	18-3095	302,00
DF80	2009-10	18-3049	511,00
DT85	1983-00	18-3095	302,00
DT90	1989-97	18-3049	511,00
DF90	2001-08	18-3023	580,00
DF90	2009-10	18-3049	511,00
DT100	1987-01	18-3049	511,00
DF100	2009-10	18-3023	580,00
DT115	1986-01	18-3023	580,00
DF115	2001-10	18-3023	580,00
DT140	1986-01	18-3023	580,00
DF140	2002-10	18-3023	580,00

Rep. sæt uden hus Varenr.	Pris
18-3260	319,00
18-3266	282,00
18-3260	319,00
18-3259	282,00
18-3266	282,00
18-3259	282,00
18-3255	419,00
18-3256	288,00
18-3255	419,00
18-3256	288,00
18-3256	288,00
18-3256	288,00
18-3242	346,00
18-3242	346,00
18-3242	346,00
18-3242	346,00
18-3242	346,00
18-3242	346,00
18-3243	407,00
18-3242	346,00
18-3243	407,00
18-3243	407,00
18-3244	421,00
18-3244	421,00
18-3254	676,00
18-3254	676,00
18-3257	684,00
18-3258	512,00
18-3257	684,00

## IMPELLER / REP.SÆT

Motor.	Årgang	Impeller Varenr.	Pris
DT150	1986-03	18-3023	580,00
DF150	2006-10	18-3023	580,00
DT175	1987-92	18-3023	580,00
DF175	2006-10	18-3023	580,00
DT200	1986-00	18-3023	580,00
DF200	2004-10	18-3035	413,00
DT225	1990-03	18-3023	580,00
DF225	2004-10	18-3035	413,00
DF250	2004-10	18-3035	413,00
DF300	2007-10	18-3035	413,00

Rep. sæt uden hus Varenr.	Pris
18-3253	707,00
18-3253	707,00
18-3253	707,00
18-3264	513,00
18-3264	513,00
18-3264	513,00
18-3267	1.184,00

## YAMAHA

### OLIEFILTER



F/T9.9 1991-2006

Varenr.	Pris
18-7901	219,00

F15, F25 1998-1999,  
F40 1998/2000,  
F/T50 1995-1999,  
F80, F100 1999

Varenr.	Pris
18-7902	141,00

F15 2007-2020, F20 2007-2020,  
F25 2009-2020, F40 2001-  
F50 2005-, F60 2005-, F70,  
T50 2005-, T60 2005-

Varenr.	Pris
18-8700	124,00

F15, F25, T25, F30 2017-2020,  
F40/F40B 2001-2008,  
F50, T50, F60, T60, F75, F80,  
F100 2000-2005,  
F115

Varenr.	Pris
18-7911-1	128,00

F150 2004-  
F200 (3,3)  
F225 (3,3)  
F250 (3,3)

Varenr.	Pris
18-7906-1	118,00

F200 (4,2), F225 (4,2), F250(4,2)  
F300 (V8), F350 (V8)

Varenr.	Pris
18-7954	313,00

### BENZINFILTER



F6, F8 2001 -

Varenr.	Pris
18-7710-1	220,00

F4 1999-2002, F6 1989, 1992-1999,  
F8 1989-99, 2001-2002,  
F9.9 1989-1995, 1997-1999, 2001-2002,  
FT 9.9 1988-1990

Varenr.	Pris
18-7713	178,00



F/T50, F/T60, F75, F90, F115, LF115

Varenr.	Pris
18-7979	224,00



F50-F115 efter april 2006  
For filter huse mærket "6D8"

Varenr.	Pris
18-79799	234,00



150-300 2004-2006  
Motor Z, VZ, LZ

Varenr.	Pris
18-7955	283,00



F150, F200, F225, F250, Z-VZ 150- 300 hk  
efter april 2006  
For filter huse mærket "6P3"

Varenr.	Pris
18-79809	247,00

## VANDUDSKILLER



Varenr.	Beskrivelse	Pris
18-7845	Lille filter	114,00



Varenr.	Beskrivelse	Pris
18-7945	Stort filter	101,00

## BENZINKOBLING



Varenr.	Slange	Pris
18-80413	6 mm.	175,00



Varenr.	Slange	Pris
18-80415	8 mm.	171,00



Varenr.	Slange	Pris
18-8076	10 mm.	85,00

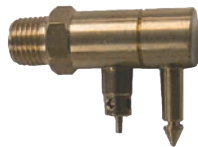

Varenr.	Gevind	Pris
18-8077-1	1/4" NPT	181,00

# SIERRA®

## Pumpebold



Pumpebold med dobbelte kontraventiler med vitonkugler og rustfri stålfejdre

EPA/CARB certificeret

Varenr.	Stuts Udv. Ø mm.	Pris
18-8002EP-1	6	386,00
18-8004EP-1	8	354,00
18-8005EP-1	10	368,00

## Benzinslange



Silverado 4000 benzinslange, er den bedste B1 benzinslange på markedet.

Den er modstadsdygtig over for ethanolblandede brændstoffer. Er meget fleksibel, og er vej, og UV resistent CPE.

Varenr.	Indv. Ø mm.	Udv. Ø mm.	Pris pr. mtr.
16-337-0146	6	11	104,00
16-337-0566	8	13	107,00
16-337-0386	10	14	110,00







## IMPELLER / REP.SÆT



# SIERRA®



Motor.	Årgang	Impeller Varenr.	Pris
T2	1984-87	18-3072	190,00
T2	1988-02	18-3072	190,00
T3	1988-02	18-8911	267,00
F2,5	2003-15	18-8911	267,00
F2,5	2016-18	18-8911	267,00
T4	1989-99	18-3073	200,00
F4	1999-13	18-3073	200,00
F4	2014-18	18-3073	200,00
T5	1995-02	18-3073	200,00
T6	1889-00	18-3066	311,00
F6	2001-08	18-8910	288,00
F6	2009-17	18-3073	200,00
T8	1989-09	18-3066	311,00
F8	2001-17	18-8910	288,00
T9,9	1986-95	18-3074	297,00
T9,9	1996-09	18-3040	276,00
F9,9	1985-05	18-3074	297,00
F9,9	2005-06	18-3040	276,00
F9,9	2007-17	18-8910	288,00
T15	1994-95	18-3074	297,00
T15	1996-09	18-3040	276,00
F15	1998-06	18-3040	276,00
F15C	2006-18	18-3040	276,00
T20	1996-97	18-3065	293,00
F20	2006-18	18-3040	276,00
T25 (2 CYL )	1989-09	18-3065	293,00
T25 (3 CYL)	1997-02	18-3068	299,00
F25	1998-05	18-3068	299,00
F25A	2009-17	18-3068	299,00
F25B	2016-17	18-3068	299,00
F25C	2016-17	18-3065	293,00
C30	1991-92	18-3068	299,00
F30	2001-05	18-3068	299,00
F30	2013-17	18-3068	299,00
T40	1988-94	18-3068	299,00
F40	2000-06	18-3068	299,00
F40A	2008-17	18-3068	299,00
F40B	2007-08	18-3068	299,00
T50	1988-94	18-3068	299,00
T50	1995-09	18-3069	389,00
C50	1998-01	18-3069	389,00
PRO 50	1988-90	18-3068	299,00
P50	1995-96	18-3069	389,00
50 JET	1986-95	18-3068	299,00
F50	1995-17	18-3069	389,00
C55	1991-95	18-3069	389,00
CV55	1989-90	18-3069	389,00

Rep. sæt uden hus Varenr.	Pris
18-3463	769,00
18-3462	848,00
18-4534	413,00
18-4532	604,00
18-3473	661,00
18-3460	488,00
18-3450	545,00
18-3473	661,00
18-3460	488,00
18-3450	545,00
18-3148	723,00
18-3433	532,00
18-3148	723,00
18-3433	532,00
18-3450	545,00
18-3148	723,00
18-3433	532,00
18-3433	532,00
18-3479	781,00
18-3431	522,00
18-3479	781,00
18-3431	522,00
18-4527	846,00
18-3440	979,00
18-3490	672,00
18-3429	537,00
18-3440	979,00
18-3490	672,00
18-3440	979,00
18-3429	537,00
18-3434	480,00
18-3434	480,00
18-3429	537,00
18-3434	480,00
18-3434	480,00
18-3425	1.150,00
18-3425	1.150,00

## IMPELLER / REP.SÆT

Motor.	Årgang	Impeller Varenr.	Pris	Rep. sæt uden hus Varenr.	Pris
T60	2004-05	18-3070	363,00	18-3370	586,00
C60	1996-01	18-3069	389,00	18-3465	497,00
E60	1995-96	18-3069	389,00	18-3465	497,00
P60	1992-99	18-3069	389,00	18-3465	497,00
F60	2002-17	18-3069	389,00	18-3434	480,00
T70	1984-91	18-3069	389,00	18-3428-1	551,00
T70	1992-03	18-3069	389,00	18-3465	497,00
T70	2004-09	18-3070	363,00	18-3370	586,00
C70	2000-01	18-3069	389,00	18-3465	497,00
F70A	2010-17	18-3069	389,00	18-3494	1.171,00
C75	1994-99	18-3070	363,00	18-3370	586,00
E75	1995-00	18-3070	363,00		
P75	1996-99	18-3070	363,00		
F75A	2003-17	18-3042	418,00	18-3494	1.171,00
F75B	2017	18-3071	331,00	18-3442	886,00
C80	1997	18-3070	363,00		
C85	1991-96	18-3070	363,00	18-3370	586,00
CV85	1998-90	18-3070	363,00	18-3370	586,00
T90	1984-09	18-3070	363,00	18-3370	586,00
B90	1997-99	18-3070	363,00		
C90	1997-01	18-3070	363,00	18-3370	586,00
F90	2003-11	18-3042	418,00	18-3451	610,00
F90A	2012-17	18-3042	418,00	18-3451	610,00
F90B	2016-17	18-3071	331,00	18-3442	886,00
VF90A	2018	18-3071	331,00	18-3442	886,00
F100	1999-00	18-3042	418,00	18-3451	610,00
F100	2001-03	18-3042	418,00	18-3451	610,00
T115	1995-01	18-3071	331,00	18-3312	916,00
T115	2002-09	18-3071	331,00	18-3312	916,00
B115	1998-99	18-3071	331,00	18-4533	801,00
C115	1991-92	18-3071	331,00	18-3372	991,00
C115	1993-00	18-3071	331,00	18-3312	916,00
P115 (62A)	1993-96	18-3071	331,00	18-3312	916,00
S115	1996-99	18-3071	331,00	18-3312	916,00
F115/LF115	2000-14	18-3071	331,00		
F115/LF115	2002-18	18-3071	331,00		
VF115	2015-17	18-3071	331,00	18-3442	886,00
C130	2001	18-3071	331,00		
C150(6E5)	1996-99	18-3071	331,00	18-3395	897,00
D150	1997-98	18-3071	331,00	18-4533	801,00
DX150	1999-05	18-3071	331,00	18-4533	801,00
L150(6R0), (6K0)	1986-91	18-3071	331,00	18-3310	979,00
L150 (6R0)	1992-99	18-3071	331,00	18-3395	897,00
LX150	1999-01	18-3071	331,00	18-3395	897,00
P150	1992-99	18-3071	331,00	18-3395	897,00
PRO V150(6J9)	1986-89	18-3071	331,00	18-3310	979,00
PRO V150D (6N9)	1990	18-3071	331,00	18-3310	979,00
PX150	1999	18-3071	331,00	18-3395	897,00
S150	1996-99	18-3071	331,00	18-3395	897,00
SX150	1999-04	18-3071	331,00	18-3395	897,00
V150	2000-08	18-3071	331,00	18-3395	897,00
VX150	2000-04	18-3071	331,00	18-3395	897,00
VZ150	2000-11	18-3071	331,00	18-3395	897,00
Z150/LZ150	2000-05	18-3071	331,00	18-3395	897,00
F150/LF150/A.B	2004-17	18-3071	331,00	18-3395	897,00

## IMPELLER / REP.SÆT

Motor.	Årgang	Impeller Varenr.	Pris	Rep. sæt uden hus Varenr.	Pris
F150C/LF150C	2017	18-3071	331,00	18-3395	897,00
VF150/A	2013-18	18-3071	331,00	18-3395	897,00
V175	2000	18-3071	331,00	18-3395	897,00
VZ175	2001-10	18-3071	331,00	18-3395	897,00
Z175	2001-05	18-3071	331,00	18-3395	897,00
F175A	2014-18	18-3071	331,00	18-3395	897,00
F175/LF175C	2017	18-3071	331,00	18-3395	897,00
VF175	2015-18	18-3071	331,00	18-3395	897,00
LX200	1999-01	18-3071	331,00	18-3395	897,00
LZ200	2000-12	18-3071	331,00	18-3395	897,00
P200	1991-99	18-3071	331,00	18-3395	897,00
SX200	1999-05	18-3071	331,00	18-3395	897,00
V200	1998-99	18-3071	331,00	18-3395	897,00
VX200	2000-05	18-3071	331,00	18-3395	897,00
VZ200	2000-05	18-3071	331,00	18-3395	897,00
VZ200	2005-09	18-3071	331,00	18-3516	1.300,00
Z200	2000-12	18-3071	331,00	18-3395	897,00
F200/LF200	2002-10	18-3071	331,00	18-3395	897,00
F200B/LF200B	2012-18	18-3071	331,00	18-3395	897,00
F200C/LF200C	2013-18	18-3071	331,00	18-3395	897,00
VF200	2009-10	18-3071	331,00		
VF200LA	2011-18	18-3071	331,00		
LX225	2000-03	18-3071	331,00	18-3395	897,00
SX225	2000-03	18-3071	331,00	18-3395	897,00
V225	1998-99	18-3071	331,00	18-3395	897,00
VX225	2000-04	18-3071	331,00	18-3395	897,00
VZ225	2003-09	18-3071	331,00	18-3516	1.300,00
F225/LF225	2005-10	18-3071	331,00	18-3395	897,00
F225A/LF225A (3,3L)	2011-17	18-3071	331,00	18-3395	897,00
F225A/LF225A (4,2L)	2011-17	18-45617-1	727,00	18-3470	2.598,00
F225B/LF225B (3,3L)	2016-17	18-3071	331,00	18-3395	897,00
F225B/LF225B (4,2L)	2016-17	18-45617-1	727,00	18-3470	2.598,00
VF225 (4,2L)	2009-18	18-3071	331,00	18-3474	1.085,00
VF225LA	2011-18	18-3071	331,00		
LX250	2000-03	18-3071	331,00	18-3395	897,00
LZ250	2003-05	18-3071	331,00	18-3395	897,00
SX250	2000-03	18-3071	331,00	18-3395	897,00
VX250	2002-04	18-3071	331,00	18-3395	897,00
VZ250	2003-09	18-3071	331,00	18-3516	1.300,00
F250/LF250(3,3L)	2005	18-3071	331,00	18-3395	897,00
F250/LF250(3,3L)	2009-11	18-3071	331,00	18-3515	1.432,00
F250A/LF250A(3,3L)	2010-17	18-3071	331,00	18-3515	1.432,00
F250A/LF250A(4,2L)	2014-17	18-45617-1	727,00	18-3470	2.598,00
F250B/LF250B(3,3L)	2008-09	18-3071	331,00	18-3515	1.432,00
F250B/LF250B(4,2L)	2016-17	18-45617-1	727,00	18-3470	2.598,00
FL250	2010	18-45617-1	727,00	18-3470	2.598,00
VF250	2009-18	18-3071	331,00	18-3474	1.085,00
VF250(XA Models)	2015-18	18-45617-1	727,00	18-3470	2.598,00
Z300	2004-06	18-3071	331,00	18-3515	1.432,00
VZ300	2004-09	18-3071	331,00	18-3516	1.300,00
F300/LF300 (5,3L)	2007-09	18-8925	516,00	18-3477	2.042,00
F300/LF300 (4,2L)	2007-09	18-45617-1	727,00	18-3470	2.598,00
F300A/LF300A	2010-18	18-45617-1	727,00	18-3470	2.598,00
F350/LF350(5,3L)	2007-09	18-8925	516,00	18-3477	2.042,00
F350A.B.C/FL.A.B.C	2007-18	18-8925	516,00	18-3477	2.042,00

## MERCUISER

### OLIEFILTER



GM 3.0 / V8 Motorer Kort filter

Varenr.	Pris
18-7824-2	105,00



GM V8 motorer Langt filter

Varenr.	Pris
18-7876-1	118,00



GM V6 motorer

Varenr.	Pris
18-7879-1	95,00



Ford motorer Langt filter

Varenr.	Pris
18-7875	134,00



2.5L/3.0L 6229718 -  
MC224 CID 6218037 -,  
GM 262 CID A331455 -  
med Carter benzin pumpe

Varenr.	Pris
18-7784	153,00

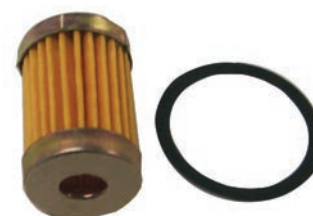

Rochester karburator

Varenr.	Pris
18-7855	84,00



4/6 cylinder rækkemotor

Varenr.	Pris
18-7860	117,00



GM 4 /6 cyl.  
Ford & Gm V-8 op til 400  
Mercuriser 224 CID

Varenr.	Pris
18-7859	78,00



MPI & EFI motorer med boost pumpe,  
8.1L & 496cid, 3/8" ID Benzin slange

Varenr.	Pris
18-7721	588,00



Rochester 2/4 port karburatorer

Varenr.	Pris
18-7717	121,00

350 Mag MPI Alpha/Bravo,  
350 Mag MPI Horizon Alpha/Bravo,  
350 Mag MPI Horizon MIE,  
350 Mag MPI MIE,  
496 MAG, 496 MAG H.O.,  
5.0 MPI Alpha/Bravo,  
8.1L Inboard, 8.1L Inboard H.O.,  
MX 6.2L MPI Alpha/Bravo,  
MX 6.2L MPI Horizon Alpha/Bravo,  
MX 6.2L MPI Horizon MIE,  
MX 6.2L MPI MIE

Varenr.	Pris
18-7977	543,00



**VANDUDSKILLER FILTER****10 MICRON**

Varenr.	Beskrivelse	Pris
18-7944	Kort - 3.875"	108,00
18-7945	Langt - 4.35"	101,00

**21 MICRON**

Varenr.	Beskrivelse	Pris
18-7844	Kort - 3.875"	105,00
18-7845	Langt - 4.35"	114,00

**10 MICRON TIL FILTER MED UNDERSKÅL**

Varenr.	Racor nr.	Pris
18-7919	S3213	345,00
18-7920	S3214	390,00
18-7947	S3240	278,00
18-7948	S3227	353,00
18-7949	S3232	487,00

Sierra Sonar er et on-line program hvor du nemt og hurtigt finder den korrekte Sierra reservedel.

Der kan søges på originalnumre, Sierra numre og motormodel.

<https://catalog.seastarsolutions.com>

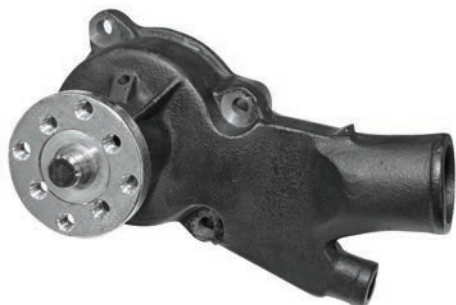
**VANDPUMPE**

GM 4 &amp; 6 cyl. rækkemotor

Varenr.	Pris
18-3593	1.646,00



GM V6 2007-

Varenr.	Pris
18-3506	4.090,00



GM V6 & V8 Small Blok

Varenr.	Pris
18-3599-2	1.546,00



GM V8 Big Blok

Varenr.	Pris
18-3577-2	2.125,00

## SØVANDPUMPE



GM V6 & V8 2000-

Varenr.	Pris
18-3160-1	4.060,00



GM V8 2-delt pump

Varenr.	Pris
18-3600	6.710,00



GM V6 & V8

Varenr.	Pris
18-36001	5.254,00



Bravo 2-delt pump

Varenr.	Pris
18-3155	1.829,00



Bravo

Varenr.	Pris
18-3237	7089,00



Alpha One gen. II

Varenr.	Pris
18-3214	501,00



Bravo

Varenr.	Pris
18-3087	308,00



GM V6 & V8

Varenr.	Pris
18-3016-1	399,00



Alpha One gen. II

Varenr.	Pris
18-3056	280,00

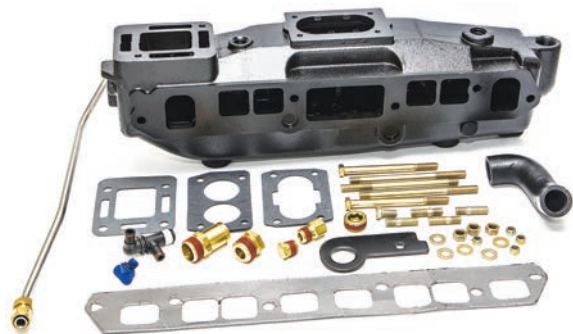
**MANIFOLD / RISER / KNÆ**

GM 2.5 &amp; 3.0L 1983 - 89

Varenr.	Pris
18-1956-3	7.268,00

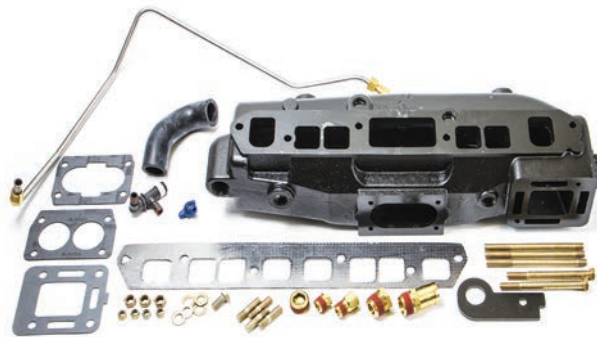

GM 3.0L 1990 -

Varenr.	Pris
18-1966-1	6.440,00



Til manifold 18-1956-3, 18-1966-1

Varenr.	Pris
18-1975-1	3.074,00

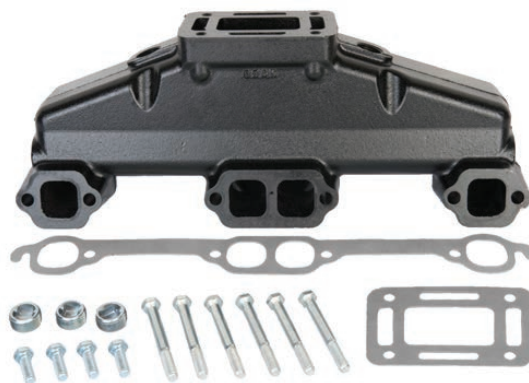

GM 283, 305, 307, 350 CID

Varenr.	Pris
18-1997-1	3.780,00



Ford 302, 351 CID

Varenr.	Pris
18-1998-1	3.798,00



4" til manifold 18-1997-1, 18-1998-1

Varenr.	Pris
18-1939	3.032,00



Monteringsæt til 18-1939

Varenr.	Pris
18-4364	208,00



GM 4.3L V6

Varenr.	Pris
18-1952-1	3.882,00



GM V8 Small Blok

Varenr.	Pris
18-1953-2	4.477,00

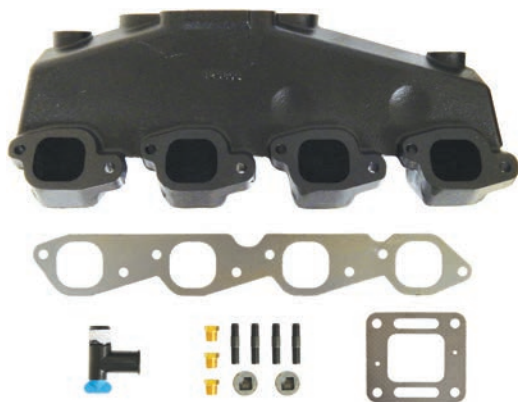

GM V8 Big Blok

Varenr.	Pris
18-1957-2	5.059,00



4" til manifold 18-1952-1, 18-1953-2, 18-1957-2

Varenr.	Pris
18-1976-2	2.613,00



3" til manifold 18-1952-1, 18-1953-2, 18-1957-2

Varenr.	Pris
18-1970-2	2.938,00

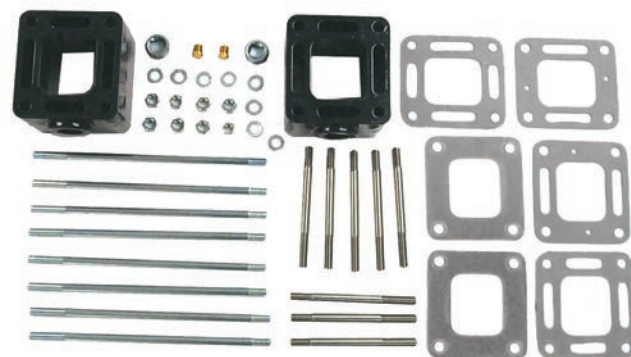

Monertringssæt til 18-1970-2

Varenr.	Pris
18-8529	190,00

3" Risersæt til manifold 18-1952-1, 18-1953-2, 18-1957-2

Varenr.	Pris
18-1908-K	4.486,00

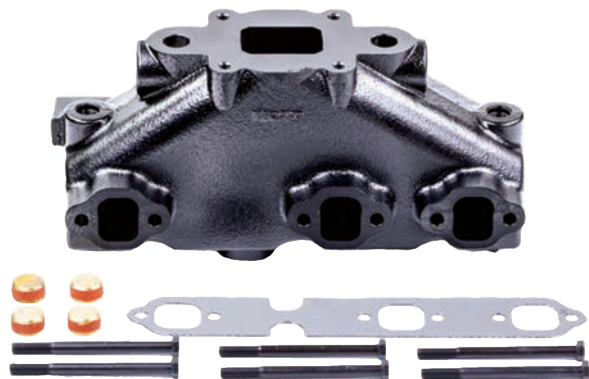

GM V6 Dry Joint

Varenr.	Pris
18-1842	5.300,00



GM V8 Dry Joint

Varenr.	Pris
18-1843	7.096,00



4" Dry Joint til manifold 18-1842, 18-1843

Varenr.	Pris
18-1845	4.750,00

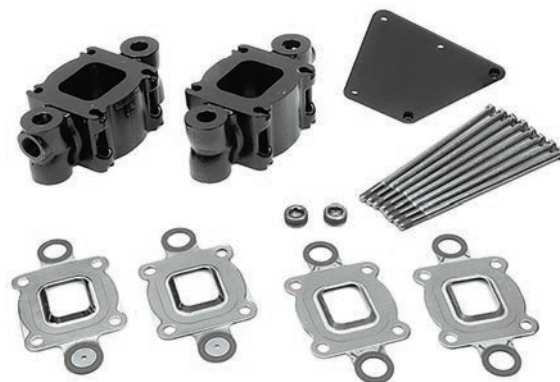

Risersæt til manifold 18-1842, 18-1843

Varenr.	Højde tommer	Pris
18-1845-1	1.7	11.380,00
18-1845-2	3	11.317,00
18-1845-3	6	12.282,00

## PAKNINGER TIL MANIFOLD / RISER / KNÆ



Dry Joint pakning "blokeret"

Varenr.	Pris
18-0720	885,00



Dry Joint pakning "åben"

Varenr.	Pris
18-0721	1.008,00



Dry Joint pakning "droslet"

Varenr.	Pris
18-0722	931,00



Varenr.	Til manifold	Pris
18-0680	18-1966-1	179,00



Varenr.	Til manifold	Pris
18-1204-1	18-1956-3	190,00



Varenr.	Til manifold	Pris
18-2949	18-1997-1 18-1953-2 18-1843	126,00



Varenr.	Til manifold	Pris
18-0183-1	18-1998-1	156,00



Varenr.	Til manifold	Pris
18-2909	18-1952-1 18-1842	102,00



Varenr.	Til manifold	Pris
18-0418	18-1957-2	205,00

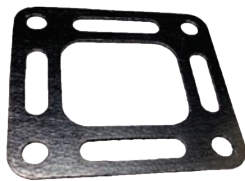

Varenr.	Til riser / knæ	Pris
18-2849-1	18-1976-2 18-1970-2	116,00

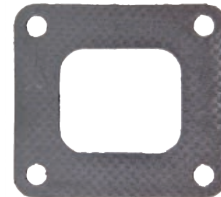

Varenr.	Til riser / knæ	Pris
18-0672	18-1976-2 18-1970-2	143,00

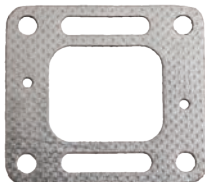

Varenr.	Til riser / knæ	Pris
18-0897	18-1976-2 18-1970-2	95,00



Varenr.	Til riser / knæ	Pris
18-2833	18-1975-1	56,00

**SIERRA®**

Varenr.	Til riser / knæ	Pris
18-2854-1	18-1939	82,00



## TRIMSENSOR

Alpha One, Bravo

Sæt med 2 stk. sensorer.



Varenr.	Pris
18-7633	1.127,00

## PAKNINGSSÆT

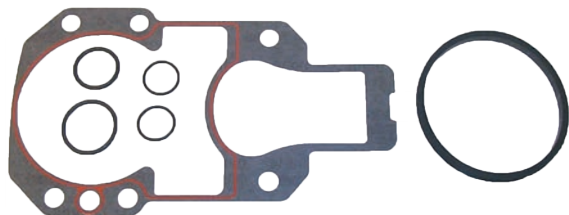

Alpha One Gen II

Varenr.	Pris
18-2619-1	84,00

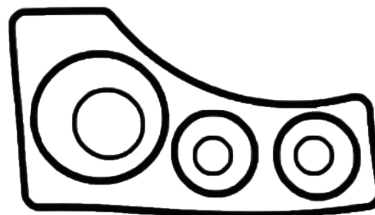

Bravo

Varenr.	Pris
18-2615	74,00

## GIMBALLEJE

Alpha One Gen II  
Bravo I/II/III

Varenr.	Leje-Type	Pris
18-21005	Åbent	1.051,00
18-21006	Lukket	1.062,00



Alpha One

Varenr.	Leje-Type	Pris
18-2100	Åbent	791,00
18-21001	Lukket	919,00

## GEARKABEL



Alpha One Gen II

Varenr.	Kabel-Type	Pris
18-2190	Standard	828,00
18-2190-E	Xtreme	2.535,00

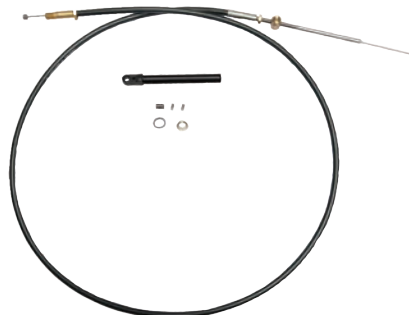

Bravo

Varenr.	Kabel-Type	Pris
18-2145	Standard	1.126,00
18-2145-E	Xtreme	2.914,00

## GEARKABELSÆT

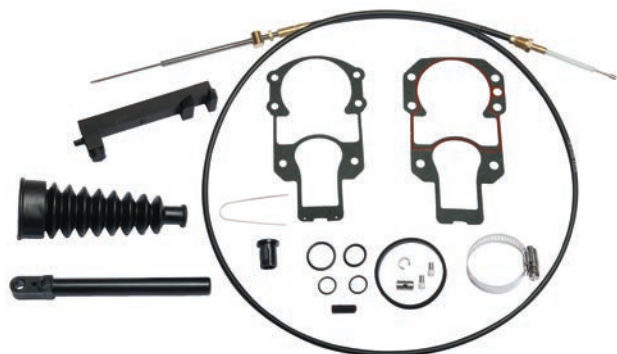

Alpha One Gen II

Varenr.	Kabel-Type	Pris
18-2603	Standard	1.132,00
18-2603-E	Xtreme	2.590,00



Bravo

Varenr.	Kabel-Type	Pris
18-2604	Standard	1.734,00
18-2604-E	Xtreme	3.398,00

## TRANSOMKIT



R, MR, Alpha One 1983-1990 S/N 6225577-0D469858,  
Alpha One SS 1986-1989 S/N 0A545004

Varenr.	Lejetype	Pris
18-2601-1	Åbent	2.537,00
18-8213	Lukket	2.674,00



R, MR, Alpha One 1983-1990 med **UDST.SLANGE**  
S/N 6225577-0D469858,  
Alpha One SS 1986-1989 med **UDST.SLANGE** S/N 0A545004

Varenr.	Lejetype	Pris
18-8205	Åbent	2.648,00
18-8217	Lukket	2.891,00



Alpha One Gen II 1991 - S/N 0D469859 -

Varenr.	Lejetype	Pris
18-8206-1	Åbent	2.791,00
18-8218	Lukket	2.736,00



Bravo I/II/III 1988 - S/N 0B664190 -,  
Blackhawk 1994-1995 S/N 0F186717-

Varenr.	Lejetype	Pris
18-8212-1	Åbent	3.253,00
18-8219	Lukket	3.188,00

**BÆLGE****UDSTØDNINGSSLANGE**Alpha 1One,  
Bravo I, II, III

Varenr.	Pris
18-2760	593,00

**UDSTØDNINGSBÆLG**Alpha One Gen II,  
Bravo I, II, III

Varenr.	Pris
18-2750	372,00

**KABELBÆLG**Alpha,  
Bravo I, II, III

Varenr.	Pris
18-2753-2	207,00

**KARDANBÆLG**

Alpha One Gen I

Varenr.	Pris
18-2751	604,00

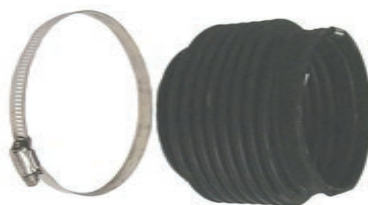
**KARDANBÆLG**

Alpha One Gen II

Varenr.	Pris
18-2747	700,00

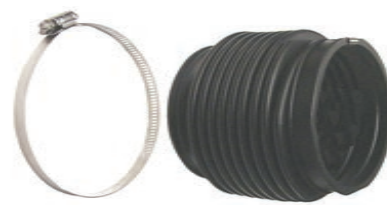
**KARDANBÆLG**Bravo,  
Blackhawk

Varenr.	Pris
18-2756	768,00

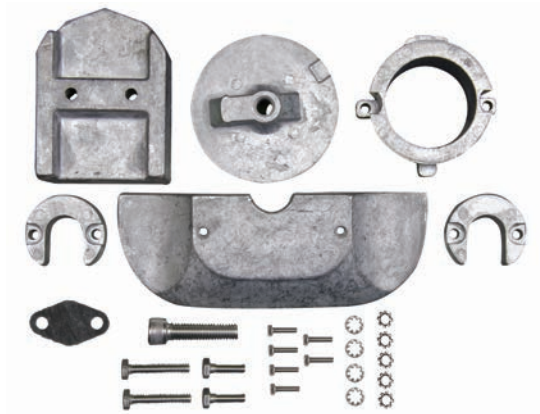
**ANODESÆT**

Alpha One Gen II 1991 -

Varenr.	Type	Pris
18-6158A	Aluminium	1.006,00
18-6158Z	Zink	912,00

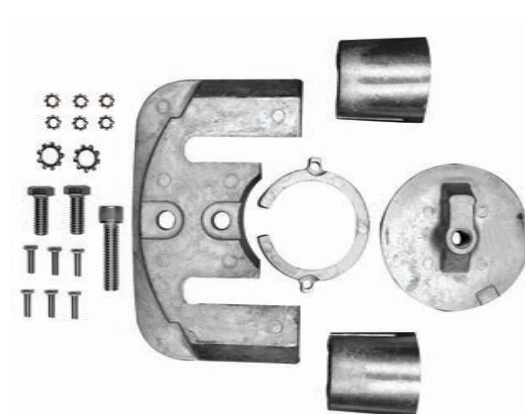

Bravo I

Varenr.	Type	Pris
18-6159A	Aluminium	974,00
18-6159Z	Zink	1.081,00

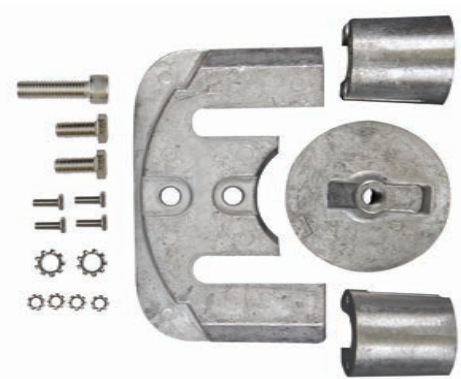

Bravo II 1989 - ,  
Bravo III 1989-2003

Varenr.	Type	Pris
18-6160A	Aluminium	705,00
18-6160Z	Zink	1.214,00

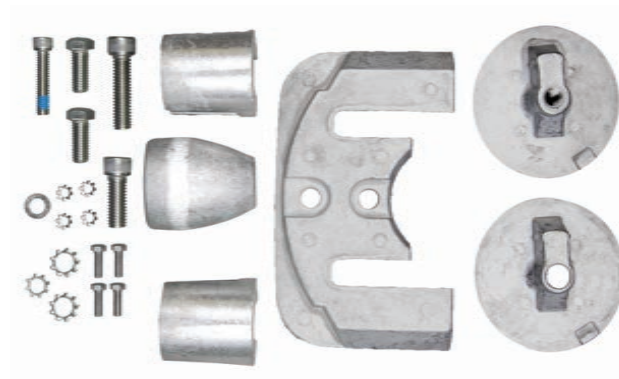

Bravo III 2004 -

Varenr.	Type	Pris
18-6154A	Aluminium	1.485,00
18-6154Z	Zink	1.668,00

Sierra Sonar er et on-line program hvor du nemt og hurtigt finder den korrekte Sierra reservedel. Der kan søges på originalnumre, Sierra numre og motormodel.

<https://catalog.seastarsolutions.com>

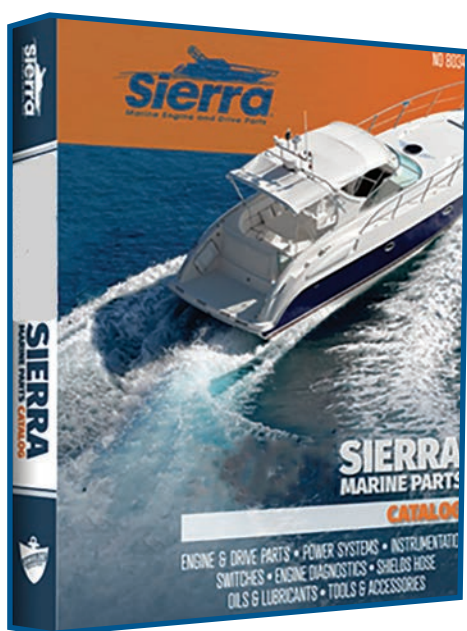

Se komplet katalog på [columbus-marine.dk](http://columbus-marine.dk)

## OMC

## OLIEFILTER



GM V6 motorer

Varenr.	Pris
18-7879-1	95,00



GM V8 motorer Kort filter

Varenr.	Pris
18-7824-2	105,00



GM V8 motorer Langt filter

Varenr.	Pris
18-7876-1	118,00



Ford motorer Langt filter

Varenr.	Pris
18-7875	134,00

# SIERRA®



M-100, M200 motorer Kort filter

Varenr.	Pris
18-7878-1	171,00

## BENZINFILTER

GM 4/6 cylinder  
Ford V8, GM V8

Varenr.	Pris
18-7859	78,00



4/6 cylinder rækkemotor

Varenr.	Pris
18-7862	195,00

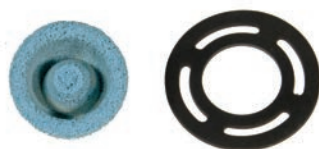

Varenr.	Pris
18-7860	117,00

3.0L 1996-1998,  
3.8L/170 (1981)

Varenr.	Pris
18-7792	275,00



Rochester karburator

Varenr.	Pris
18-7854	107,00

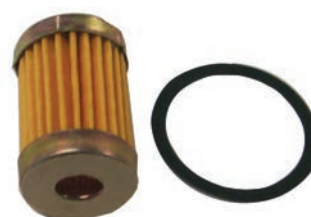

Rochester karburator

Varenr.	Pris
18-7855	84,00

## VANDUDSKILLER FILTER



10 MICRON



21 MICRON

Varenr.	Beskrivelse	Pris
18-7944	Kort - 3.875"	108,00
18-7945	Langt - 4.35"	101,00
18-7946	OMC gevind	145,00
18-7989	Cobra EFI	117,00

Varenr.	Beskrivelse	Pris
18-7844	Kort - 3.875"	105,00
18-7845	Langt - 4.35"	114,00
18-7846	OMC gevind	145,00
18-7789	Cobra EFI	119,00

### 10 MICRON TIL FILTER MED UNDERSKÅL

Varenr.	Racor nr.	Pris
18-7919	S3213	345,00
18-7920	S3214	390,00
18-7947	S3240	278,00
18-7948	S3227	353,00
18-7949	S3232	487,00



## VANDPUMPE



GM V6 & V8 Small Blok

Varenr.	Pris
18-3599-2	1.546,00



GM V8 Big Blok

Varenr.	Pris
18-3577-2	2.125,00



Cobra

Varenr.	Pris
18-3212-1	490,00



Cobra

Varenr.	Pris
18-3348	661,00



Cobra

Varenr.	Pris
18-3058	262,00

## MANIFOLD / KNÆ

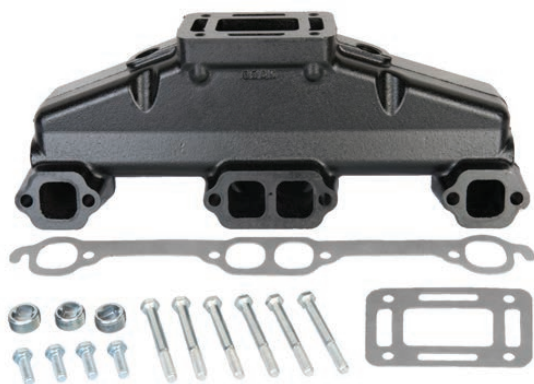

GM 283, 305, 307, 350 CID

Varenr.	Pris
18-1997-1	3.780,00



Ford 302, 351 CID

Varenr.	Pris
18-1998-1	3.798,00



4" til manifold 18-1997-1, 18-1998-1

Varenr.	Pris
18-1939	3.032,00



Monteringssæt til 18-1939

Varenr.	Pris
18-4364	208,00



4.3L V6

Varenr.	Pris
18-1848	3.652,00



GM V8 Small Blok

Varenr.	Pris
18-1986-1	4.391,00



Pakninger til 18-1848

Varenr.	Pris	Varenr.	Pris
18-2909	102,00	18-0943-2	80,00

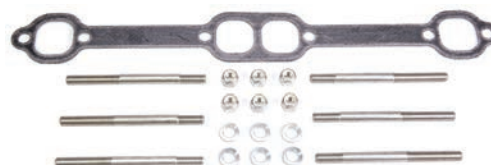

Monteringssæt til 18-1986-1

Varenr.	Pris
18-8502	779,00



4" til manifold 18-1848, 18-1986-1

Varenr.	Pris
18-1909-1	2.983,00



Monteringssæt til 18-1909-1

Varenr.	Pris
18-8507	353,00

## PAKNINGER TIL MANIFOLD / RISER / KNÆ



Varenr.	Til manifold	Pris
18-2949	18-1986-1 18-1997-1	126,00



Varenr.	Til manifold	Pris
18-0183-1	18-1998-1	156,00



Varenr.	Til manifold	Pris
18-2909	18-1848	102,00

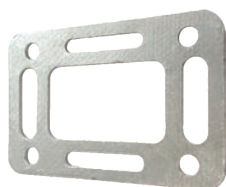

Varenr.	Til riser / knæ	Pris
18-2854-1	18-1939	82,00

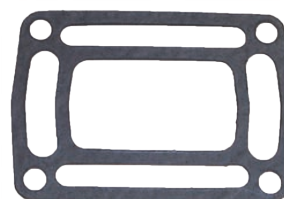

Varenr.	Til riser / knæ	Pris
18-0943-2	18-1909-1	80,00

## TRANSOMKIT

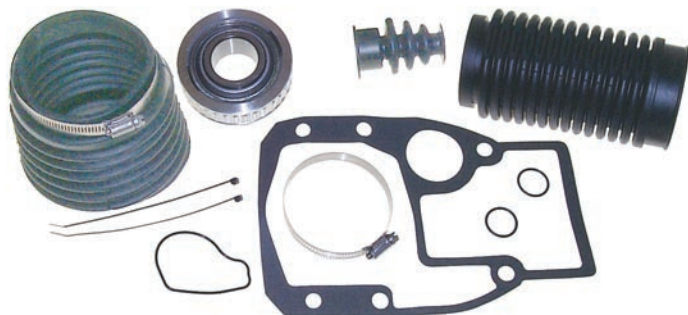

OMC Cobra uden konus kobling

Varenr.	Pris
18-2771	2.224,00



SX Cobra med konus kobling

Varenr.	Pris
18-2772-1	2.400,00

## PAKNINGSSÆT

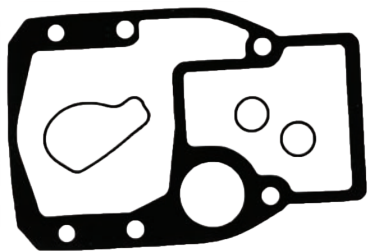

OMC Cobra

Varenr.	Pris
18-2613	66,00

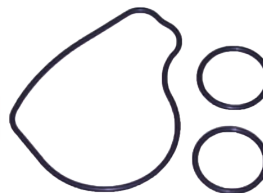

SX Cobra

Varenr.	Pris
18-2699	58,00

## GIMBALLEJE

OMC Cobra / SX Cobra

Varenr.	Leje-Type	Pris
18-2100	Åbent	791,00
18-21001	Lukket	919,00



## BÆLGE

KABELBÆLG  
Cobra

Varenr.	Pris
18-2763	156,00

UDSTØDNINGSBÆLG  
Cobra 1986-1993

Varenr.	Pris
18-2764	467,00

UDSTØDNINGSBÆLG  
Cobra 1994-

Varenr.	Pris
18-1074	541,00

KARDANBÆLG  
Cobra 1986-1993

Varenr.	Pris
18-2765	542,00

## ZINK-ANODESÆT



Cobra

Varenr.	Pris
18-6155Z	1.668,00

## VOLVO PENTA MANIFOLD / KNÆ

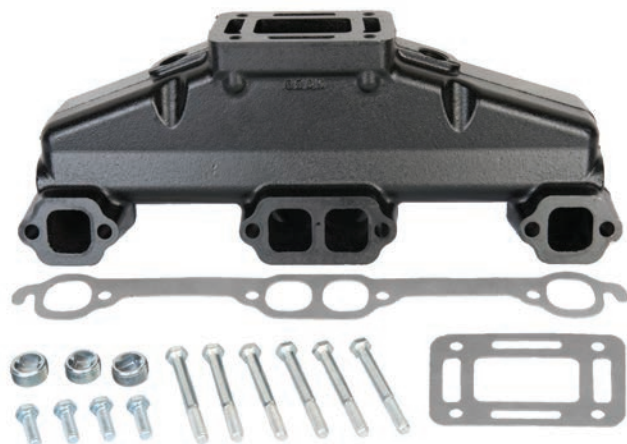

GM 283, 305, 307, 350 CID

Varenr.	Pris
18-1997-1	3.780,00

# SIERRA®



4.3L V6

Varenr.	Pris
18-1848	3.652,00



Pakninger til 18-1848

Varenr.	Pris
18-2909	102,00

Varenr.	Pris
18-0943-2	80,00



4" til manifold 18-1997-1

Varenr.	Pris
18-1939	3.032,00



Monteringsæt til 18-1939

Varenr.	Pris
18-4364	208,00



GM V8 Small Blok

Varenr.	Pris
18-1986-1	4.391,00



Monteringsæt til 18-1986-1

Varenr.	Pris
18-8502	779,00



4" til manifold 18-1848, 18-1986-1

Varenr.	Pris
18-1909-1	2.983,00



Monteringsæt til 18-1909-1

Varenr.	Pris
18-8507	353,00

## PAKNINGER TIL MANIFOLD / RISER / KNÆ



Varenr.	Til manifold	Pris
18-2949	18-1986-1 18-1997-1	126,00



Varenr.	Til manifold	Pris
18-2909	18-1848	102,00

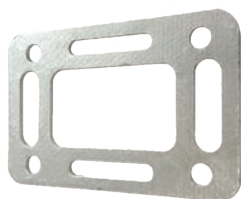

Varenr.	Til riser / knæ	Pris
18-2854-1	18-1939	82,00

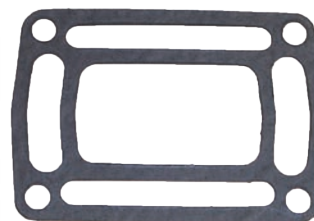

Varenr.	Til riser / knæ	Pris
18-0943-2	18-1909-1	80,00

Sierra Sonar er et on-line program hvor du nemt og hurtigt finder den korrekte Sierra reservedel.  
Der kan søges på originalnumre, Sierra numre og motormodel.

<https://catalog.seastarsolutions.com>

